

REVISIONS				
ZONE	REV	DESCRIPTION	DATE	DRAWN / APPROVED
ALL	1	ISSUED FOR REVIEW	12/23/02	J.R.
ALL	0	ISSUED FOR CONSTRUCTION	12/23/02	J.R. / A.V.
ALL	A	DIMENSIONS MODIFIED	07/27/05	R.P.

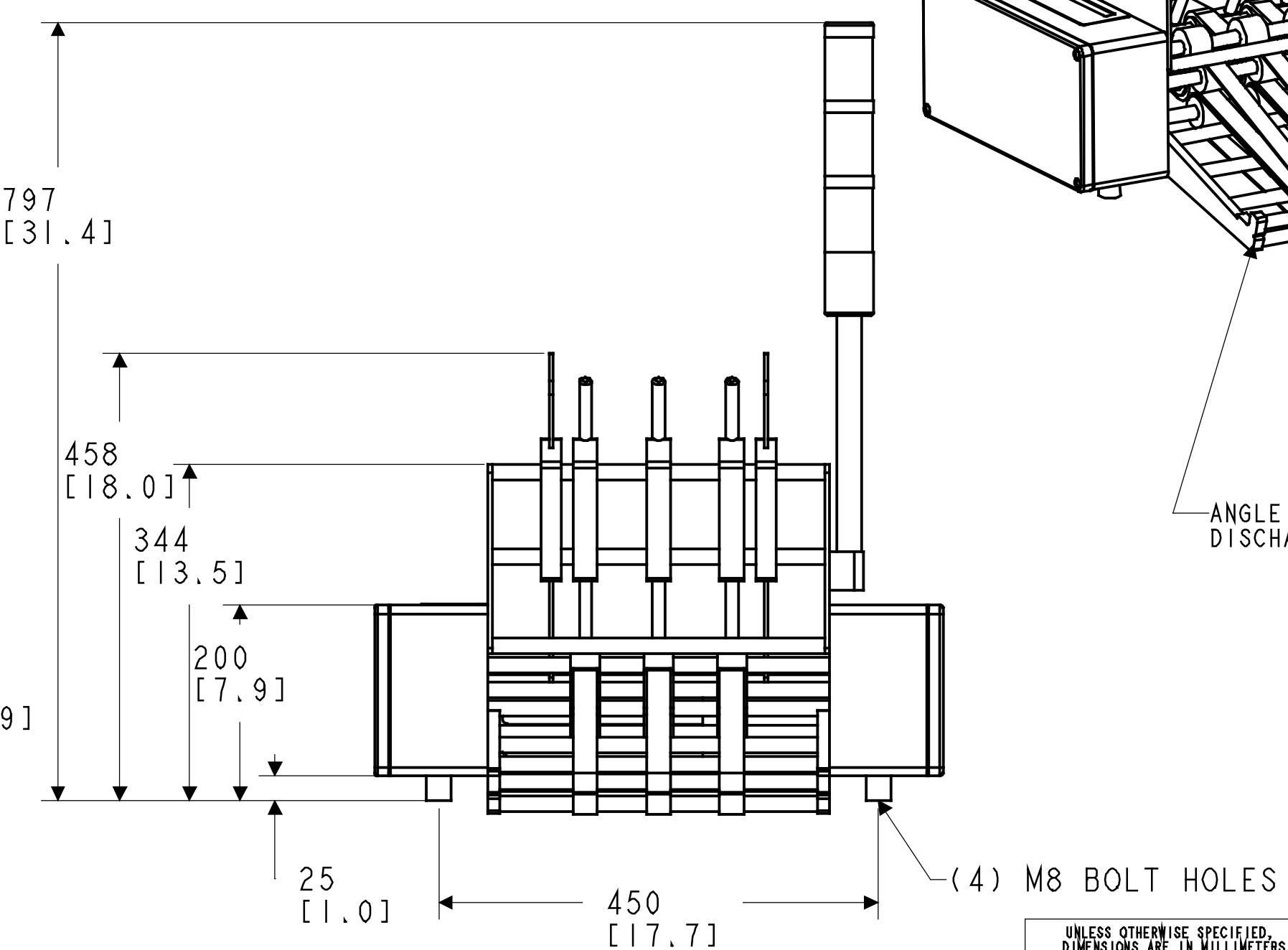
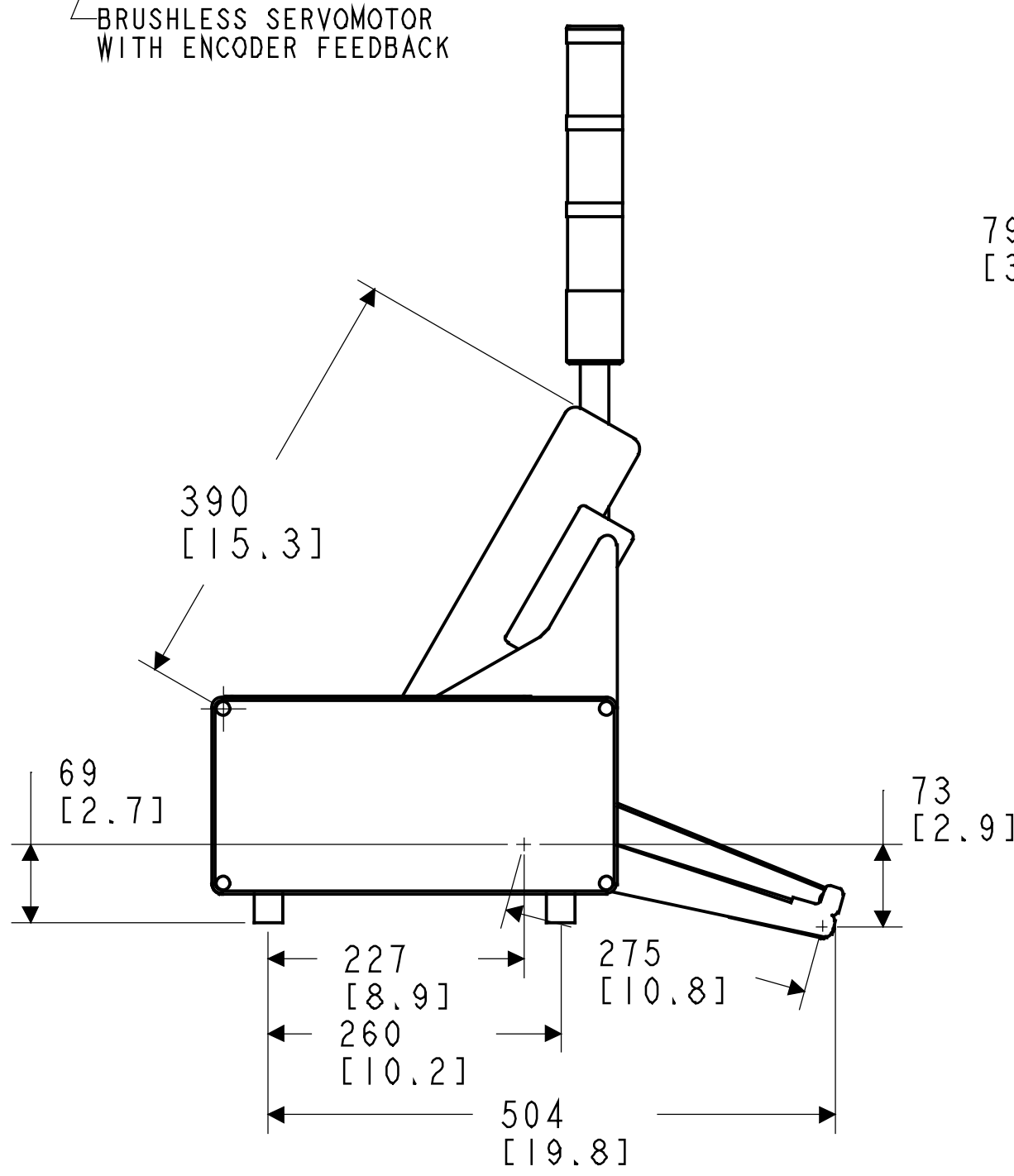
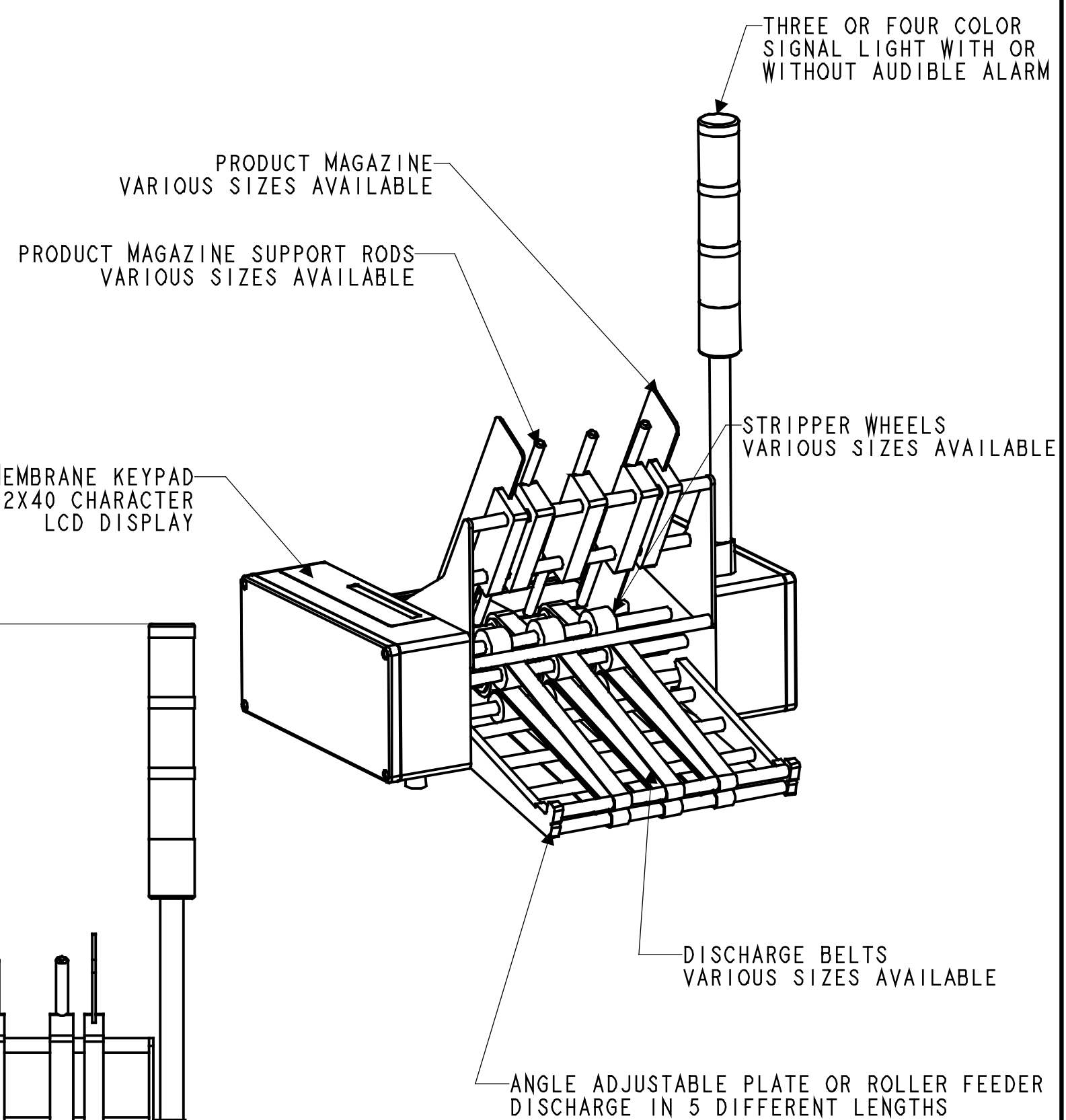
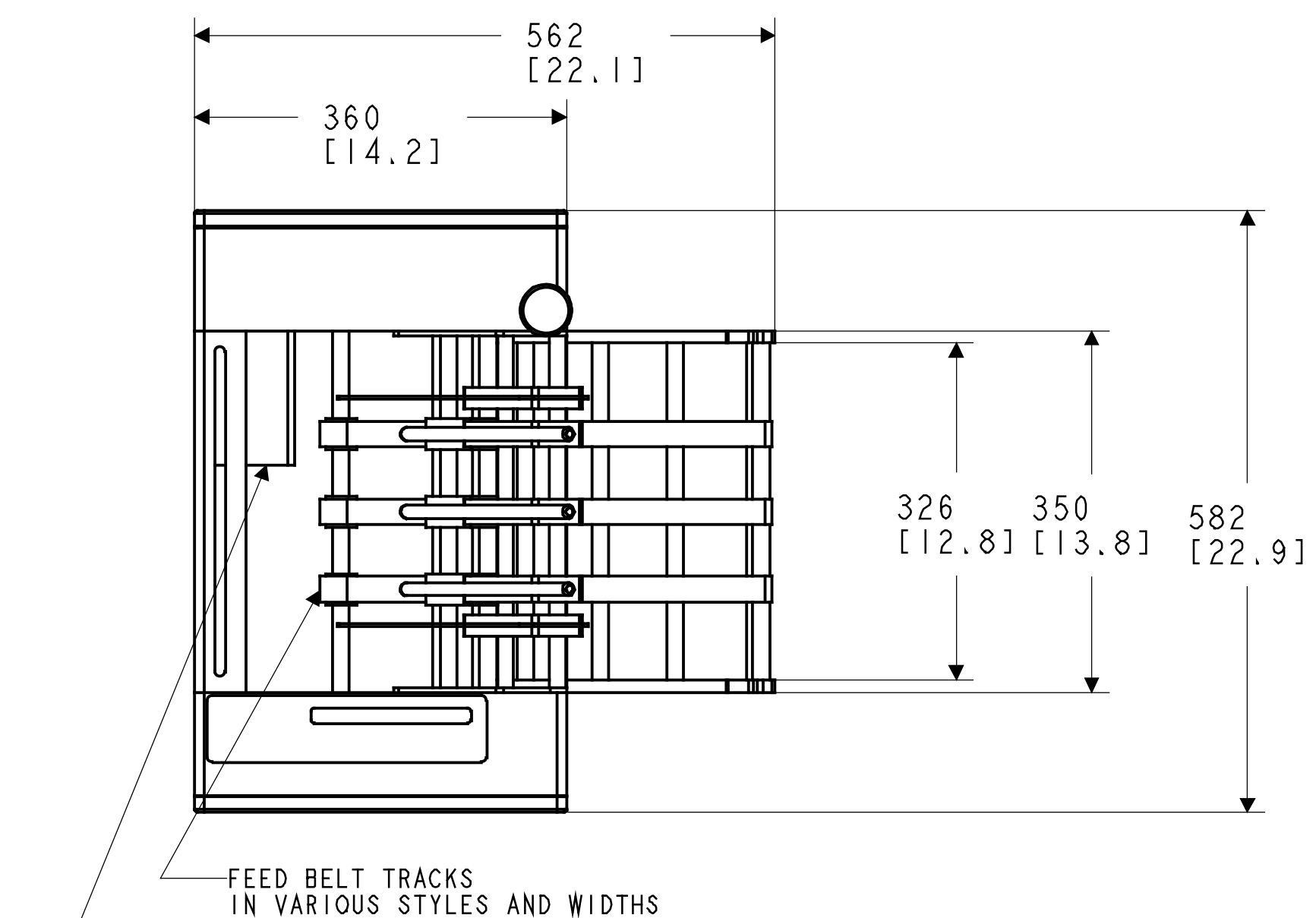

UNLESS OTHERWISE SPECIFIED, DIMENSIONS ARE IN MILLIMETERS  
TOLERANCES  
DECIMALS  
.X ± 1.25 [0.05"]  
.XX ± 0.25 [0.01"]  
.XXX ± 0.05 [0.002"]  
ANGULAR: .X ± 2.5°, .XX ± 0.5°

Multifeeder Technology, Inc.  
St. Paul, Minnesota 55110  
Phone 651.407.3100, www.multifeeder.com  
MFT350INTED

DRAWN: J.R.	DATE: 12/23/02	SIZE: C	DWG NO: 791132-0A	REV: A
CHECKED: A.V.	DATE: 12/23/02	SCALE: 0.180	Q PER MACHINE	SHEET 1 OF 1
DESIGN: A.V.	DATE: 04/08/98			

THIS DOCUMENT, SUBMITTED IN CONFIDENCE, CONTAINS PROPRIETARY AND CONFIDENTIAL INFORMATION WHICH SHALL NOT BE REPRODUCED OR TRANSFERRED TO OTHER DOCUMENTS OR DISCLOSED TO OTHERS OR USED FOR MANUFACTURING OR ANY OTHER PURPOSE, INCLUDING ADVERTISING WITHOUT PRIOR WRITTEN PERMISSION FROM A MULTIFEEDER TECHNOLOGY, INC. REPRESENTATIVE